



HAAS+SOHN

(+)

DIZAJN (+) INOVÁCIA (+) KVALITA



2011/2012

Výhody krbových kachlí

- 1 priehľadné kremičité sklo
- vysoká tepelná odolnosť až 800 °C
- poskytuje príjemný pohľad do plameňov
- 2 ochrana povrchu ohrievacieho zariadenia
- špeciálna farba s vysokou tepelnou odolnosťou
- 3 dvojitá konštrukcia plášťa
- zabepečuje rýchly ohrev vzduchu vykurovaného priestoru
- 4 uzavreté ohnisko
- vysoká energetická efektívnosť spaľovania až 85 %
- 5 bezpečný odvod spalín
- 6 možnosť ovplyvnenia spaľovania a výkonu
 - 6 I - regulácia primárneho prívodu vzduchu
 - 6 II - regulácia sekundárneho prívodu vzduchu, mechanická alebo automatická
- 7 terciárne spaľovanie
- 8 ochrana proti vypadávaniu paliva
- 9 priestor na ukladanie paliva
- 10 objemný popolník
- 11 prívod externého spaľ. vzduchu

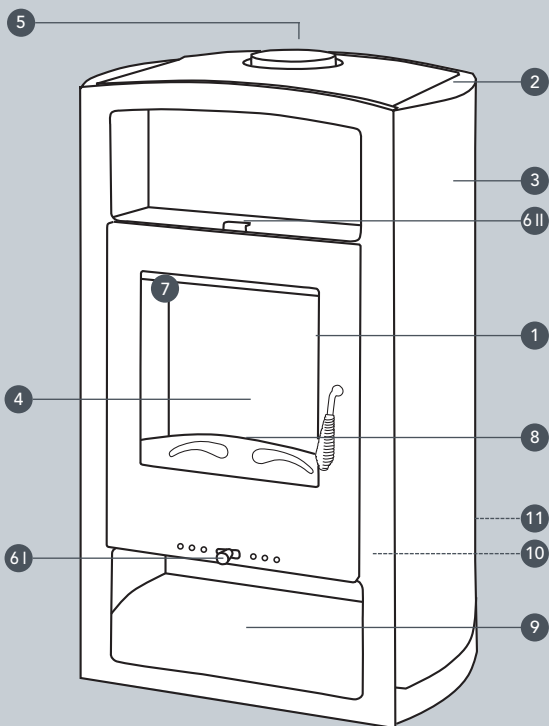

1 Novinky

2 Obstavy a krbové vložky

3 Štandardná ponuka













4 Kachle s teplovodným výmenníkom

5 Výpredaj



Technické parametre

Technické parametre kachlí

 84 Účinnosť	 Výkon (kW)
 Kusové drevo	 Rozmery výška/šírka/hĺbka (mm)
 Ekobrikety	 Hmotnosť (kg)
 Uholné brikety	 Minimálny ťah komína (Pa)
 Vrchný vývod dymovodu, priemer (mm)	 Vykurovacia schopnosť (m ³)
 Zadný vývod dymovodu, priemer (mm)	 Spotreba paliva (kg/h)
	 Rozmery skla (mm)

Technické parametre výmenníka

 Použitelný výkon do vykurovacích telies (kW)	 Vodný obsah výmenníka (l)
 Doporučený tepelný spád (t _{výstupná} - t _{vstupná}) (75-60 °C)	 Maximálny pracovný pretlak (MPa)

Inovácia



Terciárne spaľovanie – dvojité spaľovanie šetrí palivo

Proces zúžitkovávania zvyškových horľavých plynov, ktoré by za normálnych okolností unikli so splodinami nevyužitú komínom. Dochádza ku zvyšovaniu účinnosti, a tým aj nižšej spotrebe paliva.



Automatický regulátor primárneho spaľovacieho vzduchu –

predchádza problémom pri výpadku el. prúdu Pri výpadku elektrického prúdu, v momente, kedy voda vo výmenníku dosiahne 95 °C, pomocou špeciálnej termostatickej kapilárnej klapky uzatvorí prívod primárneho prísunu vzduchu do spaľovacej komory, čím znemožní horenie.



Externý prívod vzduchu (CPV) –

ideálny pre nízkoenergetický dom Možnosť prívodu spaľovacieho vzduchu z vonkajších priestorov. Neprihádza ku spaľovaniu už zohriateho vzduchu z miestnosti. Veľmi vhodné do dobre izolovaných priestorov.



Automatická regulácia sekundárneho spaľovania – optimalizácia ušetrí

Prísun sekundárneho spaľovacieho vzduchu je riadený automaticky kapilárnou klapkou umiestnenou na zadnej strane pece. Tým sa dosiahne optimálne horenie, nízke emisné hodnoty a ušetrí sa palivo = peniaze.



Ochladzovacia slučka – ochrana proti prekúreniu výmenníka

Služi ako ochrana pred prekúrením v prípade výpadku elektrického prúdu. Nie je súčasťou príslušenstva krbových kachlí.



Vymeniteľný výmenník – možnosť výmeny výmenníka za záslepku

Výmenník sa dá do pece kedykoľvek doplniť, príp. vyňať a nahradiť záslepkou. Táto vlastnosť je výhodná v prípade zapojenia alebo odpojenia vykurovacieho systému. Zjednodušuje sa tým celková starostlivosť o pec.



Akumulácia tepla

– viac tepla
Po 2 hodinách prevádzky dokáže vydávať teplo ešte ďalších 10 hodín.



Antireflexné sklo – maximálne bezpečie pre Vás a Vaše deti

Špeciálne keramické sklo s antireflexnou vrstvou odráža naspäť do ohniska teplo, ktoré by inak bežne používané sklo zohrevalo oveľa viac a na dotyk na nebezpečnejšiu teplotu. Pri letmom dotyku sa nemusíte báť, že si spôsobíte vážnejšiu popáleninu.



NAJNIŽŠIE EMISNÉ HODNOTY PRE NAJVYŠŠIE ŽIVOTNÉ HODNOTY.



Ochrana životného prostredia pre nás znamená optimálne využívanie surovín, pretože nedostatky pri spaľovaní znamenajú nedostatky v technológiách.

S Clean technology sú naše kachle už dnes produktami budúcnosti! Emisné limity, ktoré budú v Európe platné od roku 2015, nebude možné prekročiť, preto sme si už dnes štandardne stanovili za cieľ tieto limity dodržať.

Vďaka značke Clean technology Vám dávame jasný signál, že robíme všetko preto, aby sme chránili nielen prírodu ale aj Vás.

Vaše výhody:

- > menej prachových častíc znečisťujúcich vzduch
- > menej sadzí
- > menej čistenia
- > úspora paliva
- > viac životnej kvality
- > viac komfortu (pri bývaní)

Vnútorne smernice H+S pre dosiahnutie značky Clean technology:
prach < 40 mg/m³; účinnosť > 80%









NOVINKY



Avola



0427515181000	Obj. č.
2,4 - 7,4	kW 
1056/640/460	mm 
136	kg 
10	Pa 
90 - 140	m ³ 
1,1 - 2,5	kg/h 

NOVINKY

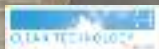

Bergamo mini



0431815030000

0431815020000

Obj. č.

2,7 - 8,3 kW

955/540/512 mm

106 kg

12 Pa

45 - 160 m³

0,6 - 2,4 kg/h



Loreto



ø 150



0332115150000



0332115120000



0332115100000



0332115130000



0332115160000

Obj. č.

2,5 - 8,2 kW 

883/750/486 mm 

126 kg 

12 Pa 

45 - 150 m³ 

0,6 - 2,4 kg/h 

NOVINKY



% 81



ø 150

Livorno



0427515171000 Obj. č.

3,5 - 7 kW

1027/550/380 mm

135 kg

10 Pa

90 - 140 m³

1,1 - 2,5 kg/h



% 81



ø 150

Malung Rainbow



0430415530000 Obj. č.

3,5 - 7 kW 

907/555/406 mm 

118 kg 

10 Pa 

90 - 140 m³ 

1,5 - 2,5 kg/h 

NOVINKY



(+)

PRVÉ SKUTOČNE 4 KW KACHLE
- ideálne pre nízkoenergetické domy

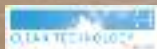

%
80



ø 120

Salerno



0420114100000 Obj. č.

2 - 4 kW

985/510/395 mm

142 kg

12 Pa

35 - 75 m³

1 kg/h

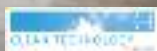

ø 150

Treviso



0332015130000



0332015100000



0332015120000



0332015150000



0332015160000

Obj. č.

2,7 - 8,3	kW	
1100/750/486	mm	
142	kg	
12	Pa	
45 - 160	m ³	
0,6 - 2,4	kg/h	



JEDINÉ KRBOVÉ KACHLE
S VYMENITELNÝM VÝMENNÍKOM



% 85



ø 150

Treviso s výmenníkom



0332015020000



0332015000000



0332015030000



0332015060000



0332015050000

(+)

JEDINÉ KRBOVÉ KACHLE
S VYMENITELNÝM VÝMENNÍKOM

%

85



ø 150

Treviso s výmenníkom



Výmenník

5,7

kW

75 - 60

°C

17

l

0,3

MPa



3,5 - 10,7

kW



1100/750/486

mm



190

kg



12

Pa



65 - 195

m³

0,8 - 3

kg/h



NOVINKY



ø 160

Ascim

Vložka Malvik



- Obstavaný priestor je z odľahčeného betónu. Viacero farebných prevedení.
- Možnosť doobjednania protipožiarnej ochrany (Obj.č. 0641851000000) nutné pri inštalácii v prípade horľavých alebo staticky citlivých stien.

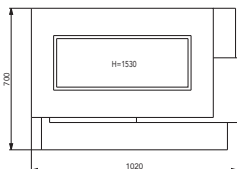

0601851010000	Obj. č.
2,4 - 8,3	kW
1530/1020/700	mm
425	kg
12	Pa
45 - 150	m ³
0,5 - 1,8	kg/h
470 x 325	mm



ø 180

Genf

Vložka Jonava



- Obstavaný priestor je z odľahčeného betónu Genf Rainbow a rímsov z masívneho dubového dreva. 0601800491000

- Možnosť doobjednania protipožiarnej ochrany (Obj.č. 0641800400000) nutné pri inštalácii v prípade horľavých alebo staticky citlivých stien.

Genf Ruivona
0601800411000

Obj. č.

2,9 - 8,8

kW

1940/1130/760

mm

445

kg

12

Pa

50 - 160

m³

0,7 - 2,5

kg/h

678 x 400

mm

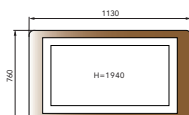

NEW



ø 160

Elsass Ruivona

Vložka Malvik



- Obstavaný priestor je z odľahčeného betónu obložený brúseným pieskovcom alebo žulovým obkladom.
- Možnosť doobjednania protipožiarnej ochrany (Obj.č. 0641850700000) nutné pri inštalácii v prípade horľavých alebo staticky citlivých stien.



Elsass Rainbow 0618516041100 Elsass Ruivona 0618516041200

2,4 - 8,3	kW	
1905/947/771	mm	
400	kg	
12	Pa	
45 - 150	m ³	
0,5 - 1,8	kg/h	
470 x 325	mm	

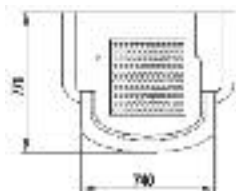



NOVINKY



Rhone Ruivona

Vložka Malvik



- Obstavaný priestor je z odľahčeného betónu obložený brúseným pieskovcom alebo žulovým obkladom.
- Možnosť doobjednania protipožiarnej ochrany (Obj.č. 0641850800000) nutné pri inštalácii v prípade horľavých alebo staticky citlivých stien.

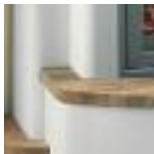

Rhone Rainbow Rhone Ruivona
0618516042100 0618516042200

2,4 - 8,3	kW	
1905/957/1013	mm	
400	kg	
12	Pa	
45 - 150	m ³	
0,5 - 1,8	kg/h	
470 x 325	mm	

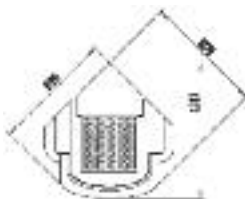



- DVOJITÉ PRESKLENIE



% 80



ø 180

Vložka Novara



0618018070000 Obj. č.

3 - 12,2	kW	
1230/778/527	mm	
179	kg	
12	Pa	
55 - 220	m ³	
3,5	kg/h	
678 x 400	mm	



- DVOJITÉ PRESKLENIE
- UŽ ZABUDOVANÁ DOCHLADZOVACIA SLUČKA



ø 180

Vložka Novara 17 s výmenníkom

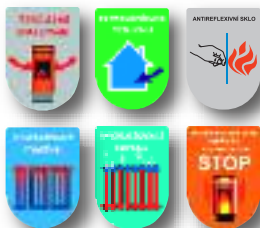

Výmenník

10,8	kW	
75 - 60	°C	
74	l	
0,2	MPa	

0618018170000 Obj. č.







5,1 - 17,4	kW	
1720/778/566	mm	
292	kg	
12	Pa	
90 - 313	m ³	
4,5	kg/h	
678 x 400	mm	



ø 180

Vložka Jonava









0618018060000	Obj. č.
2,9 - 8,8	kW 
1282/778/421	mm 
125	kg 
12	Pa 
50 - 160	m ³ 
0,7 - 2,5	kg/h 
678 x 400	mm 



ø 160

Vložka Malvik



0618516050000	Obj. č.
2,4 - 8,3	kW 
1389/430/440	mm 
115	kg 
12	Pa 
45 - 150	m ³ 
0,5 - 1,8	kg/h 
470 x 325	mm 

ŠTANDARDNÁ PONUKA



% 81



ø 150

Adria II



0431015040000

0431015050000

Obj. č.

3,2 - 10,2 kW

1050/560/442 mm

122/115 kg

12 Pa

60 - 190 m³

0,6 - 2,8 kg/h



% 78



ø 150

Adria Max



0430917040000



0430917050000

Obj. č.

3,3 - 11,6 kW 

1200/646/466 mm 

164 kg 

12 Pa 

60 - 210 m³ 

0,7 - 3,5 kg/h 

ŠTANDARDNÁ PONUKA



ø 150

Adria mini II



0431715010000



0431715020000

Obj. č.

2,5 - 8,2	kW	
890/546/414	mm	
95	kg	
12	Pa	
45 - 150	m ³	
0,6 - 2,4	kg/h	



ø 150

Arktic



Možnosť prikladania
polien s dĺžkou
až 50 cm.



0470315000000 Obj. č.

3,4 - 12	kW	
806/670/346	mm	
92	kg	
12	Pa	
55 - 220	m ³	
0,8 - 3,1	kg/h	

ŠTANDARDNÁ PONUKA



% 76



ø 150

Bergamo



4860000021 Obj. č.

3,9 - 12,1 kW

1095/660/589 mm

133 kg

12 Pa

70 - 220 m³

0,8 - 3,5 kg/h



%
78



ø 150

Grand Max



6440000011



6440000001

Obj. č.

3,3 - 11,6 kW 

1231/646/472 mm 

180 kg 

12 Pa 

60 - 210 m³ 

0,7 - 3,5 kg/h 

ŠTANDARDNÁ PONUKA



% 83



ø 150

Grand Max Plus



0431317020000



0431317050000

Obj. č.

3,5 - 13 kW

1231/646/483 mm

185 kg

12 Pa

60 - 235 m³

0,7 - 3,5 kg/h



ø 150

Grand mini II



0431615000000



0431615010000

Obj. č.

2,5 - 8,2	kW	
990/546/414	mm	
97	kg	
12	Pa	
45 - 150	m ³	
0,6 - 2,4	kg/h	

ŠTANDARDNÁ PONUKA



% 80



ø 130

Hvozdík II



3270000031



3270000021

Obj. č.

2,2 - 7,1 kW 

800/456/384 mm 

76 kg 

12 Pa 

40 - 130 m³ 







0,5 - 2 kg/h 



ø 150

Inary



0421217140000	Obj. č.
2,8 - 9,1	kW 
1188/550/565	mm 
147	kg 
12	Pa 
50 - 160	m ³ 
0,5 - 2,5	kg/h 

ŠTANDARDNÁ PONUKA



ø 150

Juva



0425515020000 Obj. č.

2,8 - 9,1 kW 

1158/514/545 mm 

154 kg 

12 Pa 

50 - 160 m³ 

0,4 - 2,5 kg/h 

ŠTANDARDNÁ PONUKA



% 83



ø 150

Kalmar



0431517040000



0431517050000

Obj. č.

3,5 - 13	kW	
1228/686/482	mm	
205	kg	
12	Pa	
60 - 235	m ³	
0,7 - 3,5	kg/h	

ŠTANDARDNÁ PONUKA



ø 150

Lugano



0331415030000

0331415020000

0331415000000

0331415010000



0331415050000

0331415060000

2,5 - 8,2	kW	
883/750/486	mm	
126	kg	
12	Pa	
45 - 150	m ³	
0,6 - 2,4	kg/h	



%
78



ø 130

Nordic



0470215110000 Obj. č.

2,6 - 8,7 kW 

685/640/330 mm 

65 kg 

12 Pa 

45 - 160 m³ 

0,7 - 2,7 kg/h 

ŠTANDARDNÁ PONUKA



Odense



5200000031



5200000011

Obj. č.

3,4 - 11,1	kW	
1051/605/405	mm	
104	kg	
12	Pa	
60 - 200	m ³	
0,8 - 3,4	kg/h	

ŠTANDARDNÁ PONUKA



ø 150

Torsby



043171500000

043171503000

Obj. č.

2,5 - 8,2 kW 

890/546/414 mm 

94 kg 

12 Pa 

45 - 150 m³ 

0,6 - 2,4 kg/h 

ŠTANDARDNÁ PONUKA



%
78



ø 130

Trentino



7020000001 Obj. č.

2,6 - 8,7 kW

626/660/350 mm

75 kg

12 Pa

45 - 160 m³

0,7 - 2,7 kg/h



%
79



ø 150

Vaasa Plus III



0430815090000



0430815030000

Obj. č.

5 - 7,5 kW 

1095/560/378 mm 

88 kg 

10 Pa 

90 - 140 m³ 

1,5 - 2,5 kg/h 

ŠTANDARDNÁ PONUKA



% 79



ø 150

Vaasa Plus IV



043081510000



0430815040000

Obj. č.

5 - 7,5 kW

900/560/378 mm

86 kg

10 Pa

90 - 140 m³

1,5 - 2,5 kg/h



%
79



ø 150

Vaasa Plus V



0430815110000



0430815050000

Obj. č.

5 - 7,5 kW 

876/560/378 mm 

85 kg 

10 Pa 

90 - 140 m³ 

1,5 - 2,5 kg/h 

ŠTANDARDNÁ PONUKA



%
74



ø 150

Varde Rund II



0430715010000 Obj. č.

5 - 7,5 kW

868/525/405 mm

102 kg

10 Pa

90 - 140 m³

1,1 - 2,5 kg/h



83



ø 150

Adria II s výmenníkom



043101500000



043101501000

Obj. č.

Výmenník

4,9

kW



75 - 60

°C



10,3

l



0,3

MPa



3,4 - 10,5

kW

1050/560/442

mm

136/129

kg

12

Pa

60 - 190

m³

0,6 - 2,8

kg/h

KACHLE S VÝMENNÍKOM



Adria Max s výmenníkom



043091700000

0430917010000

Obj. č.

Výmenník

7,3

kW

75 - 60

°C

14,3

l

0,3

MPa



4,3 - 13,7

kW

1200/646/466

mm

186

kg

12

Pa

80 - 250

m³

0,9 - 4

kg/h





Bergamo s výmenníkom



Výmenník

7 kW

75 - 60 °C

14,5 l

0,3 MPa



4860000031 Obj. č.

3,9 - 12,1 kW 

1095/660/589 mm 

161 kg 

12 Pa 

70 - 220 m³ 

0,8 - 3,5 kg/h 

KACHLE S VÝMENNÍKOM



Grand Max s výmenníkom



643000011



643000001

Obj. č.

Výmenník

7,3

kW

75 - 60

°C

14,3

l

0,3

MPa



4,3 - 13,7

kW

1231/646/472

mm

202

kg

12

Pa

80 - 250

m³

0,9 - 4

kg/h



Grand Max Plus 11 s výmenníkom



0431317000000 0431317030000

Výmenník

11,3	kW	
75 - 60	°C	
29,5	l	
0,3	MPa	

3,5 - 15	kW	
1231/646/483	mm	
225	kg	
12	Pa	
60 - 270	m ³	
0,7 - 4,1	kg/h	

KACHLE S VÝMENNÍKOM



Kalmar 11 s výmenníkom

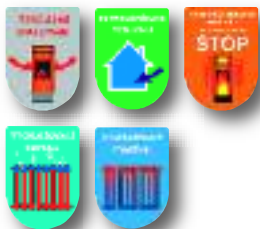

0431517000000 0431517010000

Výmenník

11,3	kW	
75 - 60	°C	
29,5	l	
0,3	MPa	

3,5 - 15	kW	
1228/686/482	mm	
249	kg	
12	Pa	
60 - 270	m ³	
0,7 - 4,1	kg/h	



Odense s výmenníkom



5200000001



5200000021

Obj. č.

Výmenník

6,4	kW	
75 - 60	°C	
10,6	l	
0,3	MPa	

4 - 12,6	kW	
1051/605/405	mm	
132	kg	
12	Pa	
70 - 230	m ³	
0,8 - 3,5	kg/h	

DO WYPREDANIA ZÁSÓB



ø 150

Grand Mini



6350000011



6300000011

Obj. č.

2,6 - 8 kW 

977/560/405 mm 

127 kg 

10 Pa 

50 - 150 m³ 

0,7 - 2,4 kg/h 



ø 130

Kaunas Lux



0432815020000



0432815010000



0432815030000

Obj. č.

2,1 - 7,2 kW 

800/612/452 mm 

110 kg 

10 Pa 

40 - 130 m³ 

0,5 - 2,6 kg/h 

DO WYPREDANIA ZÁSÓB



% 74



ø 150

Luž Mini



712000001 Obj. č.

2,7 - 8,3 kW

1070/696/583 mm

137 kg

12 Pa

50 - 150 m³

0,6 - 2,8 kg/h

DO VYPREDANIA ZÁSLOB



ø 150

Nordal



762000001



762000011

Obj. č.

2,6 - 8,6	kW	
1128/618/491	mm	
169	kg	
12	Pa	
50 - 155	m ³	
0,5 - 2,5	kg/h	

DO WYPREDANIA ZÁSÓB



% 80



ø 150

Nordland Cotto



0421515100000 Obj. č.

2,1 - 7,6 kW

1195/585/510 mm

153 kg

12 Pa

40 - 137 m³

1,9 kg/h

DO WYPREDANIA ZÁSÓB



Revel



042711500000

042711510000

Obj. č.

1,5 - 5,5	kW	
984/822/451	mm	
131	kg	
12	Pa	
30 - 100	m ³	
0,6 - 1,8	kg/h	

DO VYPREDANIA ZÁSLOB



% 74



ø 150

Storvik



0427515160000 Obj. č.

5 - 7,5 kW

1005/550/380 mm

103 kg

10 Pa

90 - 140 m³

1,1 - 2,5 kg/h

DO VYPREDANIA ZÁSOB



%
74



ø 150

Varde I



0427515110000 Obj. č.

5 - 7,5 kW

1027/550/436 mm

120 kg

10 Pa

90 - 140 m³

1,1 - 2,5 kg/h

DO VYPREDANIA ZÁSLOB



Vestre



4700000001



4700000011

Obj. č.

3,2 - 10,2	kW	
1150/640/442	mm	
125	kg	
12	Pa	
60 - 190	m ³	
0,6 - 2,8	kg/h	

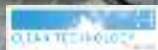

%

83



ø 150

Vestre s výmenníkom



4720000011



4720000001

Obj. č.

Výmenník

4,9

kW

75 - 60

°C

10,3

l

0,3

MPa



3,4 - 10,5

kW

1150/640/442

mm

133

kg

12

Pa

60 - 190

m³

0,6 - 2,8

kg/h



DO WYPREDANIA ZÁSÓB



ø 180

Vložka Opus



0618618100000 | Obj. č.

2,9 - 8,8	kW	
1435/805/536	mm	
195	kg	
12	Pa	
50 - 160	m ³	
0,7 - 2,5	kg/h	
634 x 346	mm	

Krbové náradie

Kôš veľký
s náradím



Kôš
hranatý



Kôš veľký
bez náradia
(ilustračné foto)



„E“ kôš
na drevo



Kôš
stredný



Kôš
oválny

Kôš
Rukov



HS I
trojdielna



HS II
trojdielna



HS III
trojdielna



Bau IV
trojdielna



Bau V
trojdielna



Náradie „B“

Príslušenstvo

Ku kachliam dodávame široký sortiment príslušenstva - trúbky, kolená, zdere (Ø 130, 150, 160 a 180 mm), žalúzie a krbové náradie.



Dymové
kolená
90°



Dymové kolená 45°



Čistič skla
krbových pecí



Dymové trúbky
bez klapiek



Dymové zdere
dvojdielné



Žalúzie



Dymové trúbky
s čistiacim otvorom



Dymové trúbky
s klapkou

Ku kachliam dodávame aj zvláštne príslušenstvo:
ochladzovacie slučky, výmenníky a záslepky.



Výmenník
Bergamo



Záslepka
Bergamo



Výmenník
Grand Max Plus 11,
Kalmar 11



Záslepka
Grand Max Plus 11,
Kalmar 11



Výmenník
Grand Max, Adria Max



Záslepka
Grand Max,
Adria Max

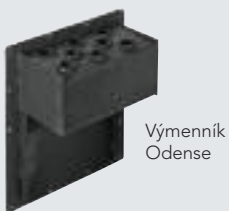

Výmenník
Odense



Záslepka
Odense



Výmenník
Vestre, Marma, Adria II

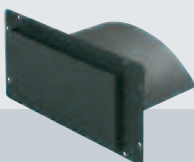

Záslepka
Vestre, Marma, Adria II



Dochladzovacia slučka
Adria II, Marma, Vestre

Cenník

krbových kachlí, krbového náradia a príslušenstva, platný od 1. 4. 2011
Aktuálnu ponuku vrátane prípadných akciových cien získate na obchodnom oddelení.

Kamna a krbové vložky - novinky

Typ	Obj. č.	MC (EUR)
AVOLA, farba čierna, pieskovec	0427515181000	780,00
BERGAMO MINI, farba čierna, béžová dlažba	0431815030000	735,00
BERGAMO MINI, antracit, šedá dlažba	0431815020000	735,00
LORETO, farba čierna, zelená kachle	0332115100000	920,00
LORETO, farba čierna, hnedá kachle	0332115120000	920,00
LORETO, farba čierna, kachle medovník	0332115130000	920,00
LORETO, farba čierna, kachle capuccino	0332115160000	920,00
LORETO, farba čierna, kachle slonová kosť	0332115150000	920,00
LIVORNO, antracit, pískovec	0427515171000	780,00
MALUNG rainbow, antracit, pískovec	0430415530000	855,00
SALERNO, antracit	0420114100000	880,00
TREVISO, farba čierna, hnedá kachle	0332015120000	995,00
TREVISO, farba čierna, zelená kachle	0332015100000	995,00
TREVISO, farba čierna, kachle medovník	0332015130000	995,00
TREVISO, farba čierna, kachle capuccino	0332015160000	995,00
TREVISO, farba čierna, kachle slonová kosť	0332015150000	995,00
TREVISO s výmenníkom*, farba čierna, hnedá kachle	0332015020000	1 195,00
TREVISO s výmenníkom*, farba čierna, zelená kachle	0332015000000	1 195,00
TREVISO s výměňíkem*, farba čierna, kachle medovník	0332015030000	1 195,00
TREVISO s výměňíkem*, farba čierna, kachle capuccino	0332015060000	1 195,00
TREVISO s výměňíkem*, farba čierna, kachle slonová kosť	0332015050000	1 195,00
Krbová stavebnica ASCIM, krbová vložka Malvik	0601851010000	1 595,00
Krbová stavebnica GENF rainbow, krbová vložka Jonava	0601800491000	1 635,00
Krbová stavebnica GENF ruivona, krbová vložka Jonava	0601800411000	1 635,00
Krbová stavebnica ELSASS ruivona, krbová vložka Malvik	0618516041200	1 530,00
Krbová stavebnica RHONE ruivona, rohový model, krbová vložka Malvik	0618516042200	1 490,00
Krbová vložka NOVARA, antracit	0618018070000	1 020,00
Krbová vložka NOVARA 17 s výmenníkom*, antracit	0618018170000	1 595,00

Teplovzdušné kachle - stála ponuka

Typ	Obj. č.	MC (EUR)
ADRIA II, farba čierna, béžová dlažba, zlaté kovanie	0431015040000	670,00
ADRIA II, antracit, strieborné dvierka a boky, chrom. kovanie	0431015050000	670,00
ADRIA MAX, farba čierna, béžová dlažba, zlaté kovanie	0430917040000	705,00
ADRIA MAX, antracit, strieborné dvierka a boky, chrom. kovanie	0430917050000	705,00
ADRIA mini II, farba čierna, béžová dlažba	0431715010000	620,00
ADRIA mini II, antracit, šedá dlažba	0431715020000	620,00
ARKTIC, farba čierna	0470315000000	550,00
BERGAMO, antracit, chromové kovanie	4860000021	980,00
GRAND MAX, antracit, šedá dlažba	6440000001	845,00
GRAND MAX, farba čierna, béžová dlažba, zlaté kovanie	6440000011	845,00
GRAND MAX PLUS, farba čierna, béžová dlažba, zlaté kovanie	0431317020000	940,00
GRAND MAX PLUS, antracit, šedá dlažba, chromové kovanie	0431317050000	940,00
GRAND mini II, farba čierna, béžová dlažba	0431615000000	635,00
GRAND mini II, antracit, šedá dlažba	0431615010000	635,00
HVOZDIK II, antracit, strieborné dvierka a boky, chrom. kovanie	3270000021	470,00
HVOZDIK II, farba čierna, béžová dlažba, zlaté kovanie	3270000031	470,00
INARY, antracit+striebro, sklenený obklad, chrom. kovanie	0421217140000	1 255,00
JUVA, šedá, sklo	0425515020000	1 570,00
KALMAR, farba čierna, béžová dlažba, zlaté kovanie	0431517040000	940,00
KALMAR, antracit, šedá dlažba, chromové kovanie	0431517050000	940,00

Typ	Obj. č.	MC (EUR)
LUGANO, farba čierna, zelená kachle	0331415000000	920,00
LUGANO, farba čierna, hnedá kachle	0331415020000	920,00
LUGANO, farba čierna, béžová kachle	0331415010000	920,00
LUGANO, farba čierna, kachle medovník	0331415030000	920,00
LUGANO, farba čierna, kachle cappuccino	0331415060000	920,00
LUGANO, farba čierna, kachle slonová kosť	0331415050000	920,00
NORDIC, farba čierna	0470215110000	450,00
ODENSE, antracit, šedá dlažba, chrom. kovanie	5200000011	760,00
ODENSE, farba čierna, béžová dlažba, zlaté kovanie	5200000031	760,00
TORSBY, farba čierna, béžová dlažba	0431715000000	620,00
TORSBY, antracit, šedá dlažba	0431715030000	620,00
TRENTINO, farba čierna, béžová dlažba	7020000001	470,00
VAASA Plus III, antracit, dvierka a veko strieborné	0430815030000	390,00
VAASA Plus III, antracit, dvierka strieborné	0430815090000	390,00
VAASA Plus IV, antracit, dvierka a veko strieborné	0430815040000	390,00
VAASA Plus IV, antracit, dvierka strieborné	0430815100000	390,00
VAASA Plus V, antracit, dvierka a veko strieborné	0430815050000	390,00
VAASA Plus V, antracit, dvierka strieborné	0430815110000	390,00
VARDE RUND II, antracit, šedé dvierka	0430715010000	477,00

Obstavby a krbové vložky

Typ	Obj. č.	MC (EUR)
Krbová stavebnica ELSASS Rainbow, vložka Malvik	0618516041100	1 530,00
Krbová stavebnica RHONE Rainbow rohový model, vložka Malvik	0618516042100	1 490,00
Krbová vložka JONAVA, antracit	0618018060000	705,00
Krbová vložka MALVIK, antracit	0618516050000	695,00

Kachle s teplovodným výmenníkom

Typ	Obj. č.	MC (EUR)
ADRIA II s výmenníkom*, farba čierna, béžová dlažba, zlaté kovanie	0431015000000	785,00
ADRIA II s výmenníkom*, antracit, strieborné dvierka a boky, chrom. kovanie	0431015010000	785,00
ADRIA MAX s výmenníkom, farba čierna, béžová dlažba, zlaté kovanie	0430917000000	825,00
ADRIA MAX s výmenníkom, antracit, strieborné dvierka a boky, chrom. kovanie	0430917010000	825,00
BERGAMO s výmenníkom*, antracit, chromové kovanie	4860000031	1 140,00
GRAND MAX PLUS 11 s výmenníkom*, farba čierna, béžová dlažba, zlaté kovanie	0431317000000	1 180,00
GRAND MAX PLUS 11 s výmenníkom*, antracit, šedá dlažba, chromové kovanie	0431317030000	1 180,00
GRAND MAX výmenník, antracit, šedá dlažba	6430000001	940,00
GRAND MAX výmenník, farba čierna, béžová dlažba, zlaté kovanie	6430000011	940,00
KALMAR 11 s výmenníkom*, farba čierna, béžová dlažba, zlaté kovanie	0431517000000	1 180,00
KALMAR 11 s výmenníkom*, antracit, šedá dlažba, chromové kovanie	0431517010000	1 180,00
ODENSE s výmenníkom, farba čierna, béžová dlažba, zlaté kovanie	5200000001	880,00
ODENSE s výmenníkom, farba antracit, šedá dlažba, chromové kovanie	5200000021	880,00

Kachle - výpredaj

Typ	Obj. č.	MC (EUR)
GRAND mini, béžová dlažba, zlaté kovanie, vrchný vývod dymovodu (v)	6300000011	592,00
GRAND mini, béžová dlažba, zlaté kovanie, zadný vývod dymovodu (zv)	6350000011	592,00
KAUNAS LUX *TK*, kachlový obklad hnedý, zlaté kovanie	0432815010000	500,00
KAUNAS LUX *TK*, kachlový obklad modrý, zlaté kovanie	0432815030000	500,00
KAUNAS LUX *TK*, kachlový obklad béžový, zlaté kovanie	0432815020000	500,00
LUŽ mini, delené sklo, béžová dlažba, zlaté kovanie	7120000001	745,00
NORDAL, serpentino, mastek	7620000011	1 180,00
NORDAL, paradiso	7620000001	1 180,00

Typ	Obj. č.	MC (EUR)
NORLAND cotto , farba čierna, kachle cotto	0421515100000	860,00
REVEL , farba čierna, biela kachle	0427115100000	799,00
REVEL , farba čierna, hnedá kachle	0427115000000	799,00
STORVIK , antracit, strieborná farba, chromové kovanie	0427515160000	530,00
VARDE I , antracit, serpentino	0427515110000	510,00
VESTRE , farba čierna, bordeaux boky, zlaté kovanie	4700000001	805,00
VESTRE , antracit, strieborné segmenty, chrom. kovanie	4700000011	805,00
VESTRE s výmenníkom* , antracit, strieborné segmenty, chromové kovanie	4720000001	925,00
VESTRE s výmenníkom* , farba čierna, bordeaux boky, zlaté kovanie	4720000011	925,00
Krbová vložka OPUS , antracit, výsuvné dverka	0618618100000	860,00

Krbové náradie - stála ponuka

Typ	Obj. č.	MC (EUR)
Kôš "oválny"	1116002400000	31,00
Kôš "stredný"	1116002500000	31,00
"E" kôš na drevo	5417400051	32,00
Kôš veľký s náradím	1116001600000	85,50
Kôš veľký bez náradia	1116002600000	74,00
Kôš Rukov	1130200010000	35,00
Kôš hranatý	1116002700000	31,00
Náradie HS I-antracit, rukojeť chrom	5417400321	61,50
Náradie HS II-antracit, rukojeť chrom	5417400331	54,50
Náradie HS III	1130140140000	33,50
Náradie BAU IV	5417400341	39,50
Náradie BAU V	1130140010000	20,00
Náradie "B"	5417400021	161,50

Cenník zvláštneho príslušenstva - stála ponuka

Typ	Obj. č. čierna/antracit	MC (EUR)
Výmenník Grand Max Plus 11, Kalmar 11	0431317006000 / 0431317007000	331,50
Výmenník Grand Max Plus 8	0431317026000 / 0431317027000	271,50
Výmenník Grand Max, Grand Max Lux, Adria Max	0464027107000 / 0464027106000	200,00
Výmenník Vestre, Marma, Adria II	0426837117000 / 0426837116000	160,00
Výmenník Odense	0426627106000 / 0426627107000	171,00
Výmenník Adria	0473027106000 / -	96,50
Výmenník Bergamo	- / 0448637116000	218,00
Výmenník Treviso	0332015006100 / -	276,50
Výmenník Novara	- / 0618018073200	560,50
Záslepka Grand Max Plus 8 (bez cihel)	0431317005700 / 0431317006700	67,50
Záslepka Grand Max Plus 11, Kalmar 11 (vrátane cihel)	0431317015700 / 0431317016700	120,00
Záslepka Grand Max, Grand Max Lux, Adria Max	0464017116004 / 0464017115004	71,00
Záslepka Vestre, Marma, Adria II	0426817106011 / 0426817105011	43,00
Záslepka Odense	0426618105004 / 0426618106004	50,00
Záslepka Adria	0473017105117 / -	31,50
Záslepka Bergamo	- / 0448617015000	64,50
Záslepna sada Treviso	0332015105000 / -	27,00
Protipožiarna ochrana Elsass	0641850700000	95,50
Protipožiarna ochrana Rhone	0641850800000	95,50
Protipožiarna ochrana Avignon/Genf	0641800400000	104,00
Protipožiarna ochrana Ascim	0641851000000	117,00
Dochladzovacia slučka Grand Max plus, Kalmar	0431317006064	73,00
Dochladzovacia slučka Vestre, Marma, Adria II, Bergamo	0436819005019	66,00
Dochladzovacia slučka Treviso	0332015005029	68,00
ZUGEX H+S 130	1120130110000	48,00
ZUGEX H+S 150	1120150110000	38,00
ZUGEX H+S 200	1120200110000	44,00
Ochranný krúžok na ZUGEX H+S 150	1105150020000	4,00
Ochranný krúžok na ZUGEX H+S 200	1105200020000	4,00

Príslušenství (černá/antracit) - novinky

Typ	Rozmer (mm)	Obj. č. čierna/antracit	MC (EUR)
Redukcia 120/150	Ø 120/150 /1,5/	1106121510000 / 1106121520000	10,50
Redukcia 130/150	Ø 130/150 /1,5/	1106131510000 / 1106131520000	10,50
Redukcia 150/180	Ø 150/180 /1,5/	1106151810000 / 1106151820000	14,00
Redukcia 150/200	Ø 150/200 /1,5/	1106152010000 / 1106152020000	15,50
Koleno segmentové	Ø 120 /1,5/	- / 1103129010000	15,50
Koleno segmentové	Ø 200 /1,5/	- / 1103209010000	22,00
Rúra dymová	0,25 m Ø 120 /1,5/	- / 1101122520000	8,00
Rúra dymová	0,25 m Ø 200 /1,5/	- / 1101202520000	11,00
Rúra dymová	0,5 m Ø 120 /1,5/	- / 1101125020000	12,50
Rúra dymová	1 m Ø 120 /1,5/	- / 1101129920000	15,00
Zdera komínová	Ø 120 /1,5/	- / 1105120120000	8,00
Zdera komínová	Ø 200 /1,5/	- / 1105200120000	12,50

Príslušenství (černá/antracit) - stálá nabídka

Typ	Rozmer (mm)	Obj. č. čierna/antracit	MC (EUR)
Rúra dymová	0,25 m Ø 180 /1,5/	1101182510000 / -	9,50
Koleno segmentové 90°	Ø 180 /1,5/	1103189010000 / -	18,50
Zdera komínová	Ø 180 /1,5/	1105180110000 / -	8,50
Rúra dymová	0,25 m Ø 160 /1,5/	1101162510000 / -	9,00
Koleno segmentové 90°	Ø 160 /1,5/	1103169010000 / -	16,50
Zdera komínová	Ø 160 /1,5/	1105160110000 / -	7,50
Koleno segmentové 90°	Ø 150 /1,5/	7000841 / 7200001	16,50
Koleno segmentové 45°	Ø 150 /1,5/	7101881 / 7200291	16,50
Koleno segmentové s čistiacim otvorom 90°	Ø 150 /1,5/	7101711 / 7200011	21,50
Koleno segmentové 90°	Ø 130 /1,5/	7000851 / 7200021	15,50
Koleno segmentové 45°	Ø 130 /1,5/	7101871 / 7200281	15,50
Koleno segmentové s čistiacim otvorom 90°	Ø 130 /1,5/	7101701 / 7200031	20,50
Rúra dymová	1 m Ø 150 /1,5/	7000921 / 7200041	21,50
Rúra dymová s klapkou	1 m Ø 150 /1,5/	7101741 / 7200051	29,50
Rúra dymová s čistiacim otvorom	1 m Ø 150 /1,5/	7101791 / 7200061	25,00
Rúra dymová	1 m Ø 130 /1,5/	7000931 / 7200071	19,50
Rúra dymová s klapkou	1 m Ø 130 /1,5/	7101771 / 7200081	27,00
Rúra dymová s čistiacim otvorom	1 m Ø 130 /1,5/	7101801 / 7200091	23,00
Rúra dymová	0,5 m Ø 150 /1,5/	7000861 / 7200101	14,00
Rúra dymová s klapkou	0,5 m Ø 150 /1,5/	7101731 / 7200111	22,00
Rúra dymová s čistiacim otvorom	0,5 m Ø 150 /1,5/	7101811 / 7200121	17,50
Rúra dymová	0,5 m Ø 130 /1,5/	7000871 / 7200131	12,50
Rúra dymová s klapkou	0,5 m Ø 130 /1,5/	7101761 / 7200141	20,50
Rúra dymová s čistiacim otvorom	0,5 m Ø 130 /1,5/	7101821 / 7200151	16,00
Rúra dymová	0,25 m Ø 150 /1,5/	7000881 / 7200161	9,00
Rúra dymová s klapkou	0,25 m Ø 150 /1,5/	7101721 / 7200171	17,50
Rúra dymová	0,25 m Ø 130 /1,5/	7000891 / 7200191	8,00
Rúra dymová s klapkou	0,25 m Ø 130 /1,5/	7101751 / 7200201	16,00
Zdera komínová	Ø 150 /1,5/	7001571 / 7200221	7,00
Zdera komínová	Ø 130 /1,5/	7001561 / 7200231	6,50
Žalúzie	Ø 150 /1,5/	7101681 / 7200241	43,50
Žalúzie	Ø 130 /1,5/	7101691 / 7200251	41,00
Čistič skla		4999999991	7,00

Vysvetlivky: /1,5/ - hrúbka materiálu (mm)

zv - zadný vývod dymovodu, vv - vrchný vývod dymovodu

antracit - povrchová úprava v čiernostriebornej farbe

(pri typoch, kde farba nie je uvedená, je použitý čierny odtieň)

Pri kachliach označených * je možnosť doplniť výmenník ochladzovaciau slučkou.

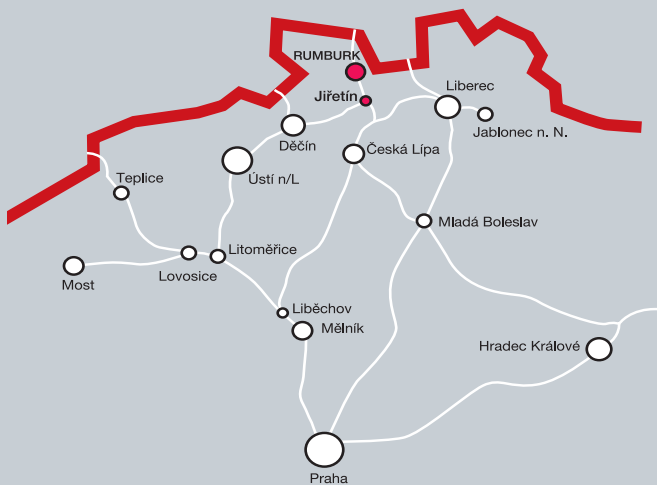

HAAS + SOHN Rukov s. r. o.

SNP 474

408 01 Rumburk

Česká republika

tel.: +420/412 332 353

tel./fax: +420/412 332 345

e-mail: odbyt@haassohn.com

www.haassohn-rukov.cz/sk

Predajca

Výrobca si vyhradzuje právo na drobné konštrukčné úpravy.